

NOTES:

- 1) TRACER WIRE, STOCK ITEM #45-7500, TO BE INSTALLED PER THE GAS CONSTRUCTION SPECIFICATIONS.
- 2) ALL WIRE SPLICES TO BE MADE USING A SPLIT BOLT CONNECTOR WRAPPED WITH AQUA-SEAL AND ELECTRICAL TAPE.

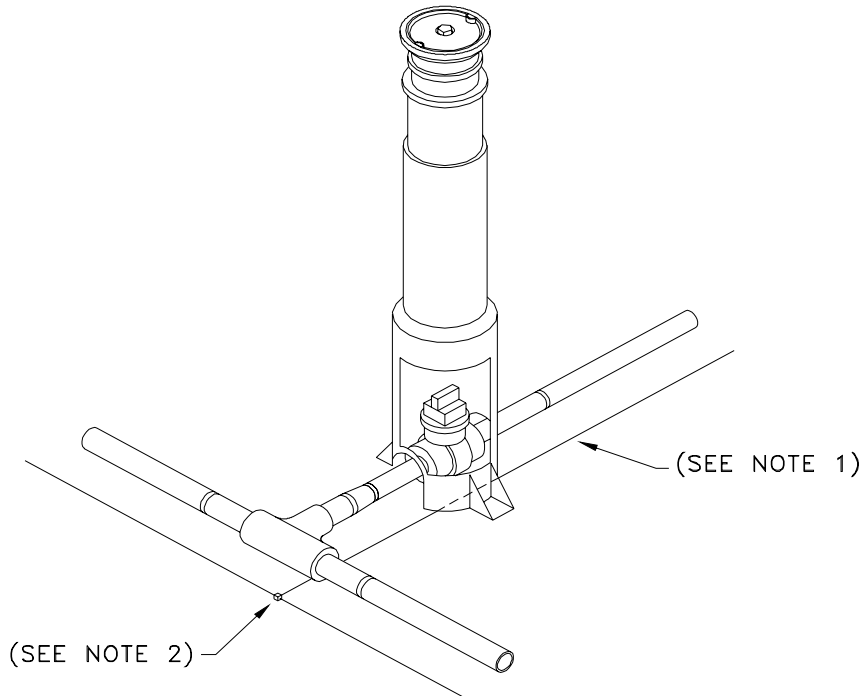

MATERIAL LIST

STOCK #	QTY.	DESCRIPTION
45-2230	1.0	TEE 4" IPS BUTT FUSION PE3408
45-1757	1.0	REDUCER 4" X 2" IPS BUTT FUSION PE3408
43-2030	1.0	VALVE 2" PE3408
43-0018	1.0	BOX 1-1/4" AND 2" PE VALVES TRAFFIC RATED H-20
19-1670	1.0	CONN SPLIT BOLT COPPER MAX #10 STR



ENGINEERING & CONSTRUCTION STANDARD

SECTION 5 GAS CONSTRUCTION DRAWINGS  
DISTRIBUTION BRANCH INSTALLATIONS

4" PE RUN X 2" PE BRANCH

SHEET 3 OF 16

DRAWING NUMBER

**DBI02G**

DRAWN	DESIGN	SUPR	DATE	REV
KS	KS	HB	5/98	7/06