

NOTES:

- 1) ALL WIRE SPLICES TO BE MADE USING A SPLIT BOLT CONNECTOR WRAPPED WITH AQUA-SEAL AND ELECTRICAL TAPE.
- 2) TRACER WIRE FOR PE GAS MAINS TO BE AWG #14 COPPERCLAD STAINLESS STEEL WITH SOLID YELLOW INSULATION.
- 3) TRACER WIRE, STOCK ITEM #45-7500, TO BE INSTALLED PER THE CONSTRUCTION SPECIFICATIONS.

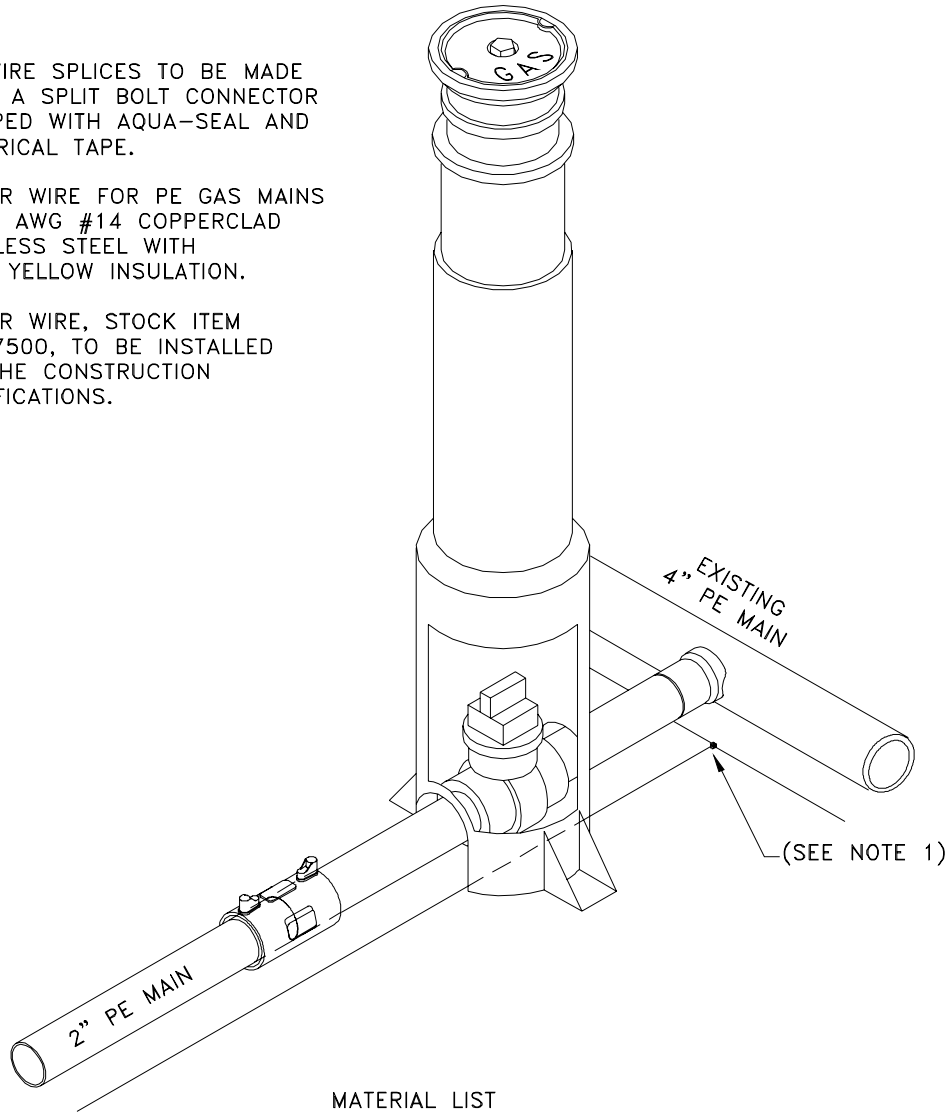

MATERIAL LIST

STOCK #	QTY.	DESCRIPTION
43-2030	1.0	VALVE 2" PE3408
45-5010	1.0	SADDLE BRANCH PLEXCO 4" X 2" PE3408 BUTT FUSION
45-0642	1.0	COUPLING ELECTROFUSION 2" IPS
43-0018	1.0	BOX 1-1/4" AND 2" PE VALVES TRAFFIC RATED H-20
45-7500	10.0	WIRE, TRACER YELLOW #14
19-1670	1.0	CONN SPLIT/BOLT COPPER MAX #10 STR



ENGINEERING & CONSTRUCTION STANDARD

SECTION 5 GAS CONSTRUCTION DRAWINGS
 DISTRIBUTION TAP INSTALLATIONS
 STANDARD TAP
 2" TAP OFF 4" PE

SHEET 4 OF 20

DRAWING NUMBER

DTI02G

DRAWN	DESIGN	SUPR	DATE	REV
GD	KS	HB	5/98	7/06