

NOTES:

- 1) COAT ALL STEEL PIPE WITH PRIMER, PROTECTO-WRAP AND TAPE. COAT VALVE WITH MASTIC, EXCEPT FOR VALVE STEM.
- 2) INSTALL MULTI-VALVE INDICATOR.

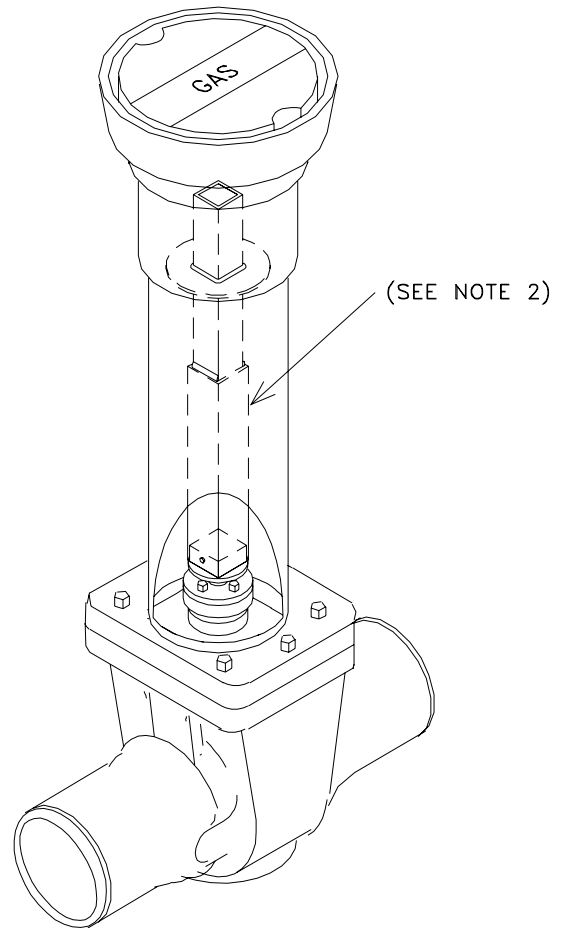

MATERIAL LIST

STOCK #	QTY.	DESCRIPTION
43-0140	1.0	VALVE 8" WELD ENDS
43-0035	1.0	EXTENSION STEEL VALVE INDICATOR
43-0010	1.0	BOX 6" VALVE CAST IRON
43-0095	1.0	COVER BOX VALVE GAS 6"
41-3000	3.0	PIPE PVC 6" SEWER 6.275 O.D. SDR 35 FOR VALVES
47-0260	1.0	TAPE PROTECTO-WRAP 6 IN. X 50 FT.
47-0300	1.0	TAPE BLACK 2 IN. X 100 FT.
47-0182	0.5	MASTIC
47-0180	0.5	PRIMER



ENGINEERING & CONSTRUCTION STANDARD

SECTION 5 GAS CONSTRUCTION DRAWINGS
DISTRIBUTION VALVE INSTALLATIONS
8" STEEL VALVE

SHEET 5 OF 6

DRAWING NUMBER

DVI04G

DRAWN	DESIGN	SUPR	DATE	REV
KS	KS	DS	5/98	7/06