

NOTES:

- A) THIS COMPATIBLE UNIT REQUIRES A 1 1/4" RISER.
- B) DASHED LINE REPRESENTS MINIMUM SPACE REQUIREMENTS FOR THIS METER SET.
- C) REGULATOR AND ORIFICE TO BE SIZED AND DISTRIBUTED BY THE GAS METER SHOP.
- D) HOUSE LINES MUST HAVE METAL TAG STAMPED WITH ADDRESS.
- E) CUSTOMER SHALL STUB OUT HOUSE LINES 4" FROM FINISH FACE OF BUILDING AND INSTALL 3/4" 90 DEGREE ELBOWS HAND TIGHT.
- F) DIMENSIONS ABOVE ARE MINIMUM REQUIREMENTS FOR METER ACCESSIBILITY. ADDITIONAL GAS METER LOCATION REQUIREMENTS IN SECTION 6 OF THIS VOLUME MUST ALSO BE ADHERED TO.



ENGINEERING & CONSTRUCTION STANDARD
 SECTION 5 GAS CONSTRUCTION DRAWINGS
 GAS METER INSTALLATIONS
 250 CFH
 14 METERS (STACKED)

SHEET 22 OF 55

DRAWING NUMBER
GMI14G

DRAWN	DESIGN	SUPR	DATE	REV
GD	KS	DS	5/98	7/06

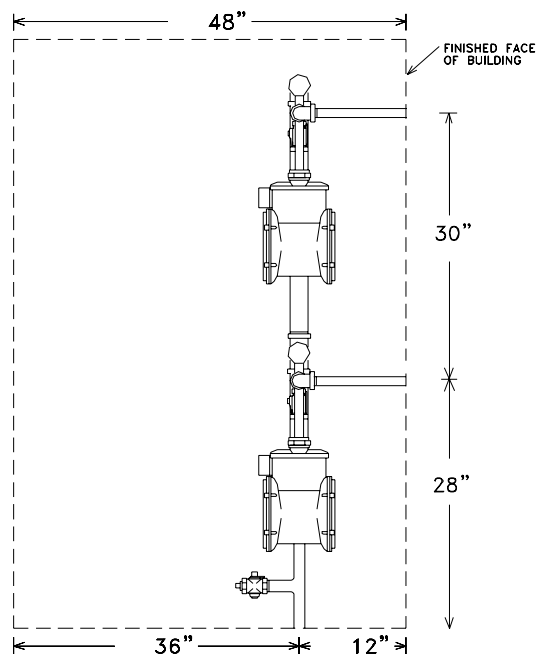

MATERIAL LIST

STOCK #	QTY.	DESCRIPTION
45-1310	1.0	NIPPLE PIPE 1 1/4" X 1 1/2" BLACK
45-1830	1.0	REDUCER 2" X 1 1/4" BLACK
45-1510	2.0	NIPPLE PIPE 2" X CLOSE BLACK
45-2140	1.0	TEE PIPE 2" BLACK
45-1600	2.0	NIPPLE PIPE 2" X 12" BLACK
45-2360	1.0	UNION PIPE 2" BLACK
45-0760	1.0	ELBOW BLACK 90 DEGREE 2"
45-1107	2.0	MANIFOLD 7-METER 2" SCH 40 PIPE W/3" X 3/4" OUTLETS
43-0040	14.0	COCK GAS METER 3/4"
45-0720	14.0	ELBOW BLACK 90 DEGREE 3/4"
45-1110	14.0	NIPPLE PIPE 3/4" X 1 1/2" BLACK
45-1206	14.0	NIPPLE PIPE 3/4" X 12" BLACK
45-2100	14.0	TEE PIPE 3/4" BLACK
45-1710	14.0	PLUG PIPE 3/4" BLACK



ENGINEERING & CONSTRUCTION STANDARD

SECTION 5 GAS CONSTRUCTION DRAWINGS
GAS METER INSTALLATIONS
250 CFH
14 METERS (STACKED)

SHEET 23 OF 55

DRAWING NUMBER

GMI14G

DRAWN	DESIGN	SUPR	DATE	REV
GD	KS	DS	5/98	7/06